

DHU10430

4MP 30x PTZ HDCVI Camera



- 1/3" 4Megapixel CMOS
- Powerful 30x optical zoom
- 120dB true WDR, 3D DNR
- Max. 25/30fps@4M/1080P, 25/30/50/60fps@720P
- IP67, IK10



System Overview

Featuring with powerful optical zoom and accurate pan/tilt/zoom performance, the SD60 series PTZ camera can provide large monitoring range and great detail. The camera delivers 4MP resolution at 25/30 fps, with 30x optical zoom. SD60 series PTZ is equipped with quick and smooth control, high quality image and good protection, which make it can meet most of the requirements of video surveillance applications.

Functions

Simplicity

HDCVI technology inherits the born feature of simplicity from traditional analog surveillance system, making itself a best choice for investment protection. HDCVI system can seamlessly upgrade the traditional analog system without replacing existing coaxial cabling. The plug and play approach enables full HD video surveillance without the hassle of configuring a network.

Wide Dynamic Range

Embedded with industry leading wide dynamic range (WDR) technology, vivid pictures are achieved even in the most intense contrast lighting conditions. For applications with both bright and low lighting conditions that change quickly, true WDR (120dB) optimizes both the bright and dark areas of a scene at the same time to provide usable video.

Environmental

With a temperature range of -40 °C to +70 °C (-40 °F to +158 °F), the camera is designed for extreme temperature environments. The camera complies to an IK10 impact rating making it capable of withstanding the equivalent of 55 kg (120 lbs) of force. Subjected and certified to rigorous dust and water immersion tests, the IP67 rating makes it suitable for demanding outdoor applications.

Protection

This camera suits even the harsh conditions for outdoor applications. Its 6KV lightning rating provides protection against the camera and its structure from the effects of lightning.

Technical Specification

Camera

Image Sensor	1/3" CMOS
Effective Pixels	2592(H) x 1520(V), 4 Megapixels
Scanning System	Progressive
Electronic Shutter Speed	1/3s~1/300,000s
Minimum Illumination	Color: 0.05Lux@F1.6; B/W: 0.005Lux@F1.6
S/N Ratio	More than 55dB
IR Distance	N/A
IR On/Off Control	N/A
IR LEDs	N/A

Lens

Focal Length	4.5mm~135mm
Max. Aperture	F1.6 ~ F4.4
Angle of View	H: 60° ~ 2.2°
Optical Zoom	30x
Focus Control	Auto/Manual
Close Focus Distance	100mm~ 1000mm

DORI Distance

*Note: The DORI distance is a "general proximity" of distance which makes it easy to pinpoint the right camera for your needs. The DORI distance is calculated based on sensor specification and lab test result according to EN 62676-4 which defines the criteria for Detect, Observe, Recognize and Identify respectively.

Detect	Observe	Recognize	Identify
2700m(8858ft)	1080m(3543ft)	540m(1772ft)	270m(886ft)

PTZ

Pan/Tilt Range	Pan: 0° ~ 360° endless; Tilt: -20° ~ 90°, auto flip 180°
Manual Control Speed	Pan: 0.1° ~ 300° /s; Tilt: 0.1° ~ 150° /s
Preset Speed	Pan: 600° /s; Tilt: 500° /s
Presets	300
PTZ Mode	5 Pattern, 8 Tour, Auto Pan ,Auto Scan
Speed Setup	Human-oriented focal Length/ speed adaptation
Power up Action	Auto restore to previous PTZ and lens status after power failure
Idle Motion	Activate Preset/ Scan/ Tour/ Pattern if there is no command in the specified period
Protocol	DH-SD, Pelco-P/D (Auto recognition)

Video

Resolution	4M(2592x1520) / 1080P(1920x1080) / 720P(1280x720)
Frame Rate	25/30fps@4M/1080P, 25/30/50/60fps@720P
Video Output	1-channel BNC high definition video output/ CVBS standard definition video output (switchable)
Day/Night	Auto(ICR) / Color / B/W

OSD Menu	Support
Backlight Compensation	BLC / HLC / WDR (120dB)
White Balance	Auto,ATW,Indoor,Outdoor,Manual
Gain Control	Auto / Manual
Noise Reduction	Ultra DNR (2D/3D)
Digital Zoom	16x
Flip	180°
Privacy Masking	Up to 24 areas

Certifications

Certifications	CE: EN55032/EN55024/EN50130-4 FCC: Part15 subpartB,ANSI C63.4- 2014 UL: UL60950-1+CAN/CSA C22.2, No.60950-1
----------------	---

Interface

Video Interface	1
Audio Interface	1 channel in
RS485	1
Alarm	2/1

Electrical

Power Supply	AC24V/3A(±25%)
Power Consumption	12W,20W (Heater on)

Environmental

Operating Conditions	-40°C ~ 70°C (-40°F ~ +158°F) / Less than 90% RH
Ingress Protection	IP67
Vandal Resistance	IK10

Construction

Casing	Metal
Dimensions	Φ222(mm) x 297(mm)
Net Weight	6.2kg(13.67lb)
Gross Weight	7.5kg(16.53lb)

Accessories

Included:



PFB303W
Wall Mount



PFA111
Mount Adapter



AC24V/3A
Power Supply

Optional:



PFA140
Power box



PFB300C
Ceiling Mount



PFA120
Junction Box



PFA150
Pole Mount





PFA151
Corner Mount

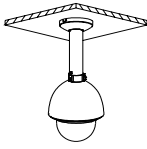
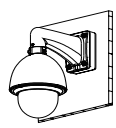
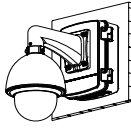
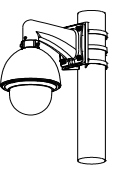

PFB303S
Parapet Mount

Rev 001.001 © 2016 Dahua®, All rights reserved.

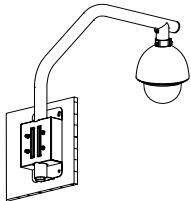
Ceiling Mount	Junction Mount
PFA111 + PFB300C	PFA111 + PFB303W + PFA120
	
Power Box Mount	Pole Mount
PFA111 + PFB303W + PFA140	PFA111 + PFB303W + PFA150
	
Corner Mount	Parapet Mount
PFA111 + PFB303W + PFA151	PFA111+ PFB303S
	

Dimensions (mm)

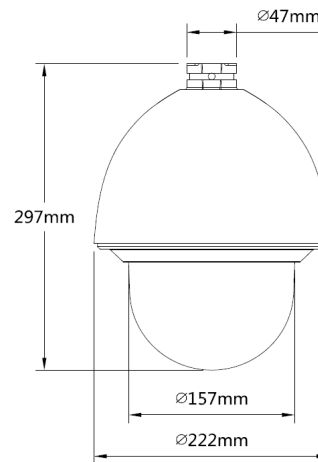

SEADAN PRODUCT NUMBER

DHU10430 (SD60430I-HC)

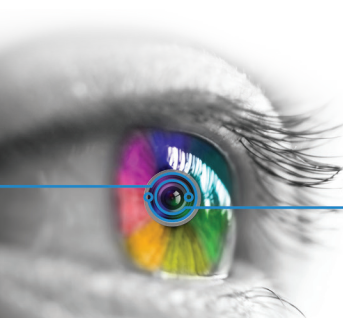

You're in very secure company

VIC Unit 7, 170 Forster Road, Mt Waverley VIC 3149
 NSW Unit 5, 142 James Ruse Drive, Parramatta NSW 2150
 QLD 15-19 Hudson Road, Albion QLD 4010
 WA Unit 4, 200 Balcatta Road, Balcatta WA 6021
 ACT Unit 2, 157-161 Gladstone Street, Fyshwick ACT 2609

1300 366 851 | seadan@seadan.com.au

20171121